ST-NXP Wireless

IMPORTANT NOTICE

Dear customer,

As from August 2nd 2008, the wireless operations of NXP have moved to a new company, ST-NXP Wireless.

As a result, the following changes are applicable to the attached document.

- **Company name - Philips Semiconductors** is replaced with **ST-NXP Wireless**.
- **Copyright** - the copyright notice at the bottom of each page “© Koninklijke Philips Electronics N.V. 200x. All rights reserved”, shall now read: “© ST-NXP Wireless 200x - All rights reserved”.
- **Web site** - <http://www.semiconductors.philips.com> is replaced with <http://www.stnwireless.com>
- **Contact information** - the list of sales offices previously obtained by sending an email to sales.addresses@www.semiconductors.philips.com, is now found at <http://www.stnwireless.com> under Contacts.

If you have any questions related to the document, please contact our nearest sales office. Thank you for your cooperation and understanding.

ST-NXP Wireless

Document information

| Info | Content |
|-----------------|---|
| Keywords | ISP1581, USB, universal serial bus, MPEG, peripheral controller |
| Abstract | This document explains the use of the Philips ISP1581 Hi-Speed Universal Serial Bus (USB) MPEG2 Encoder Reference demo board in terms of jumper settings and connector pin assignments. A basic board testing procedure is also provided. |

Revision history

| Rev | Date | Description |
|------------|---------------|--|
| 3.0 | April 2004 | - Updated Section 2. - Changed terminology from "interface device" to "peripheral controller". |
| 2.0 | December 2003 | Changed the power supply input voltage from 5 V to 12 V: <ul style="list-style-type: none">• Table 8-2• Section 7.6• Section 12. |
| 1.0 | January 2003 | USB MPEG2 Encoder Reference Kit first release |

Contact information

For additional information, please visit: <http://www.semiconductors.philips.com/>

For sales office addresses, please send an email to: sales.addresses@www.semiconductors.philips.com



This is a legal agreement between you (either an individual or an entity) and Philips Semiconductors. By accepting this product, you indicate your agreement to the disclaimer specified as follows:

DISCLAIMER

PRODUCT IS DEEMED ACCEPTED BY RECIPIENT. THE PRODUCT IS PROVIDED "AS IS" WITHOUT WARRANTY OF ANY KIND. TO THE MAXIMUM EXTENT PERMITTED BY APPLICABLE LAW, PHILIPS SEMICONDUCTORS FURTHER DISCLAIMS ALL WARRANTIES, INCLUDING WITHOUT LIMITATION ANY IMPLIED WARRANTIES OF MERCHANTABILITY, FITNESS FOR A PARTICULAR PURPOSE, AND NON-INFRINGEMENT. THE ENTIRE RISK ARISING OUT OF THE USE OR PERFORMANCE OF THE PRODUCT AND DOCUMENTATION REMAINS WITH THE RECIPIENT. TO THE MAXIMUM EXTENT PERMITTED BY APPLICABLE LAW, IN NO EVENT SHALL PHILIPS SEMICONDUCTORS OR ITS SUPPLIERS BE LIABLE FOR ANY CONSEQUENTIAL, INCIDENTAL, DIRECT, INDIRECT, SPECIAL, PUNITIVE, OR OTHER DAMAGES WHATSOEVER (INCLUDING, WITHOUT LIMITATION, DAMAGES FOR LOSS OF BUSINESS PROFITS, BUSINESS INTERRUPTION, LOSS OF BUSINESS INFORMATION, OR OTHER PECUNIARY LOSS) ARISING OUT OF THIS AGREEMENT OR THE USE OF OR INABILITY TO USE THE PRODUCT, EVEN IF PHILIPS SEMICONDUCTORS HAS BEEN ADVISED OF THE POSSIBILITY OF SUCH DAMAGES.

Contents

| | | |
|--------|---|----|
| 1. | Introduction | 6 |
| 2. | System Requirements..... | 6 |
| 3. | Connection Diagram..... | 6 |
| 4. | PCBA View..... | 7 |
| 5. | Device Driver and Application Software..... | 7 |
| 5.1. | Introduction | 7 |
| 5.2. | Preparing for Software Installation..... | 8 |
| 5.2.1. | Installing the Device Driver | 8 |
| 5.2.2. | Installing the Decoder | 8 |
| 5.3. | Using the Application Software | 9 |
| 5.3.1. | Board Initialization..... | 9 |
| 5.3.2. | Running the Application | 11 |
| 6. | Advanced Debugging Function..... | 12 |
| 6.1. | Using Advanced Debugging Function | 12 |
| 6.2. | Using the SAA7114 Button..... | 12 |
| 6.3. | Using the SAA6752 Button..... | 13 |
| 6.4. | Using the I ² C Control Button | 13 |
| 6.5. | Using the SW Reset Button | 13 |
| 7. | Hardware Description..... | 14 |
| 7.1. | Video-Input Interface | 14 |
| 7.2. | Analog Audio-Input Interface | 14 |
| 7.3. | MPEG Stream (PS Stream) Output Interface..... | 14 |
| 7.4. | I ² C-Bus Interface | 14 |
| 7.5. | USB Device Endpoints..... | 15 |
| 7.6. | Power Supply..... | 15 |
| 8. | Connector Pin information..... | 15 |
| 9. | Jumper and Test Points | 16 |
| 10. | LED Indicators | 17 |
| 11. | RESET Switches | 17 |
| 12. | Schematics..... | 17 |
| 13. | Bill of Materials | 27 |
| 14. | Known Issues | 28 |
| 15. | References | 28 |



Microsoft and Windows are either registered trademarks or trademarks of Microsoft Corp. in the United States and/or other countries. The names of actual companies and products mentioned herein may be the trademarks of their respective owners. All other names, products, and trademarks are the property of their respective owners.

1. Introduction

The Philips ISP1581 Hi-Speed Universal Serial Bus (USB) MPEG2 Encoder Reference Kit is a development tool that consists of an MPEG2 encoder demo board, firmware source code for the onboard microcontroller, and a complete set of documents. This kit guides you in how analog video signals from various sources (S-Video or composite signal) are converted to digital video signals, which are then compressed to an MPEG2 bitstream by the onboard MPEG2 encoder chip. The bitstream is transferred to the PC through a high-speed USB pipe. This kit is very suitable for video capture card applications and digital video (DV) applications.

This document explains the use of the demo board in terms of jumper settings and connector pin assignments. A basic board testing procedure is also provided.

2. System Requirements

- Requires a PC with the following configurations:
 - An 800 MHz Pentium III (or equivalent) CPU or faster
 - A Video Graphics Adaptor (VGA) card with video resolution of 800 x 600 or greater
 - A sound card
 - A hard disk with 300 Mbytes or greater free space
 - System memory size of 128 Mbytes or greater
 - A Hi-Speed USB Host Controller
 - Microsoft Visual C++.
- Operating system supported: Microsoft® Windows® 2000 and Microsoft Windows XP.

3. Connection Diagram

To perform a functionality test, an Audio/Video (AV) source device is required. Its audio and video output signals should be connected to the audio and video input jacks of the demo board, respectively. See Figure 3-1.

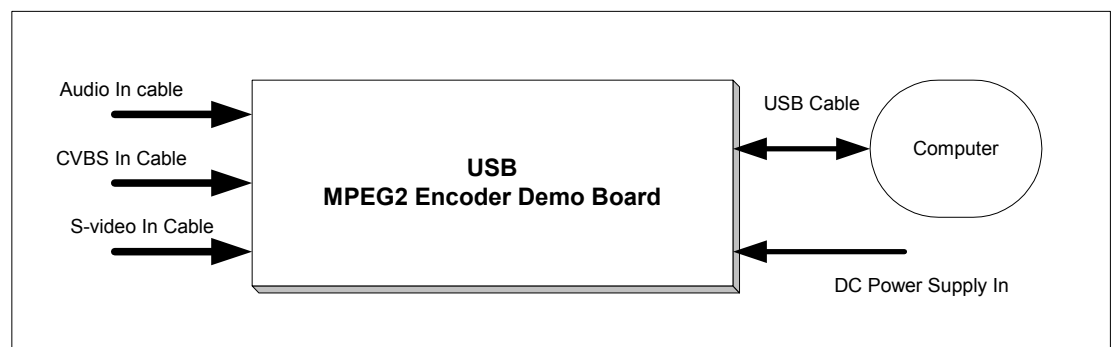

Figure 3-1: Connection Block Diagram

4. PCBA View

Figure 4-1 shows the printed circuit board (PCB) assembly of a USB MPEG2 Encoder reference kit designed using the Philips ISP1581.

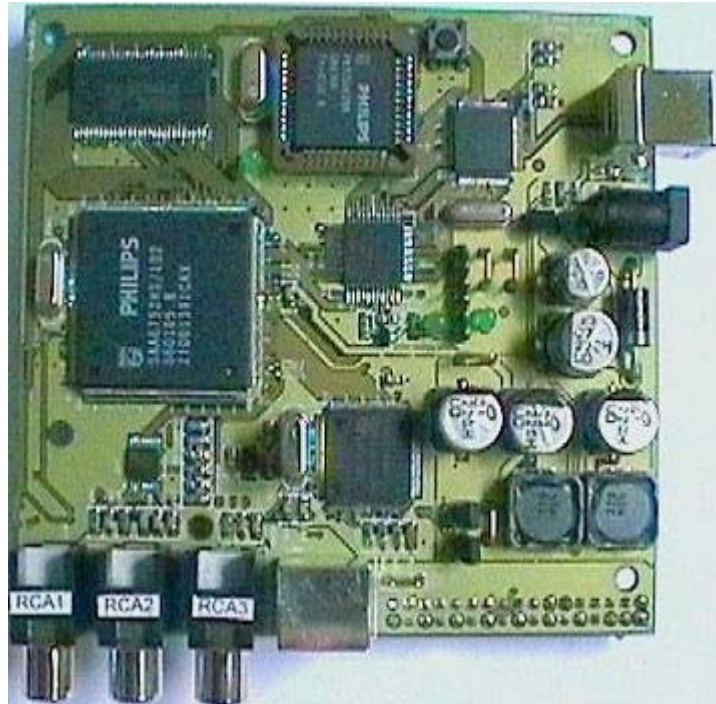

Figure 4-1: PCB Assembly

5. Device Driver and Application Software

5.1. Introduction

The device driver and the application software are stored on a source diskette in mpegtestsuite.zip. The source diskette contains the following files:

- mpegtestsuite.zip
- readme.txt

Unzip mpegtestsuite.zip, you will obtain the following directory structure:

- <drive>:\Application\
- <drive>:\Driver\
- <drive>:\InitFiles\
- <drive>:\Decoder\

5.2. Preparing for Software Installation

Create a directory called "C:\philipsMpeg"¹, and move the following three unzipped directories to this directory.

- <drive>:\Application\
- <drive>:\Driver\
- <drive>:\Decoder\

Copy files in directory "<drive>:\InitFiles*.*" to directory "C:\philipsMpeg". By default, the application software searches initial files under directory C:\philipsMpeg and, therefore, whenever the device is initialized, the application prompts for the current path of the file.

Note: Copy file MSVCRTD.DLL from the Application directory to the WINNT\System32\ directory, if the file is not present on your PC.

5.2.1. Installing the Device Driver

Connect the device to the system. When the system prompts for the INF file, redirect the system to the C:\philipsMpeg\Driver directory and load the driver by using the INF file.

5.2.2. Installing the Decoder

To install the supplied decoder, run the "register.bat" DOS batch file. This file can be found in directory C:\philipsMpeg\Decoder. The decoder consists of eight software components.

The contents of the register.bat batch file are:

- regsvr32 pim2null.ax
- regsvr32 mpgdec.ax
- regsvr32 mpeg2dmx.ax
- regsvr32 pva_dmx.ax
- regsvr32 mlcom.ax
- regsvr32 windivx.ax
- regsvr32 ball.ax
- regsvr32 mpg2spl.tl.ax

¹ It is strictly recommended to name the directory as philipsMpeg and must be located under the C drive.

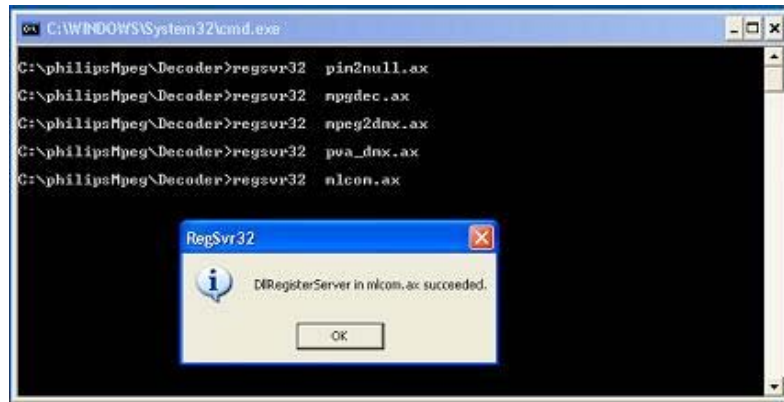

Figure 5-1: Contents of the register.bat Batch File

When running the DOS batch file, carefully check messages (see Figure 5-1) to ensure that all components are successfully loaded.

5.3. Using the Application Software

This application software handles board initialization and MPEG2 stream transfer. Before running this application, make sure that all the cables are connected and A/V sources are present. For details on connection, see Section 8.

The initialization process is explained in the following sections.

5.3.1. Board Initialization

You can start the application software either by double-clicking the **MPEG.exe**¹ icon present in the C:\PhilipsMPEG directory, or by double-clicking the **MPEG.exe** icon on your desktop if you have already created a shortcut.

To initialize the board, select a proper TV standard under the *Capture* menu. For example: **Initialize PAL** (see Figure 5-2) or **Initialize NTSC** (see Figure 5-3). S-Video is a default video input source.

¹ In this document, items that you click or type are indicated in **bold**.

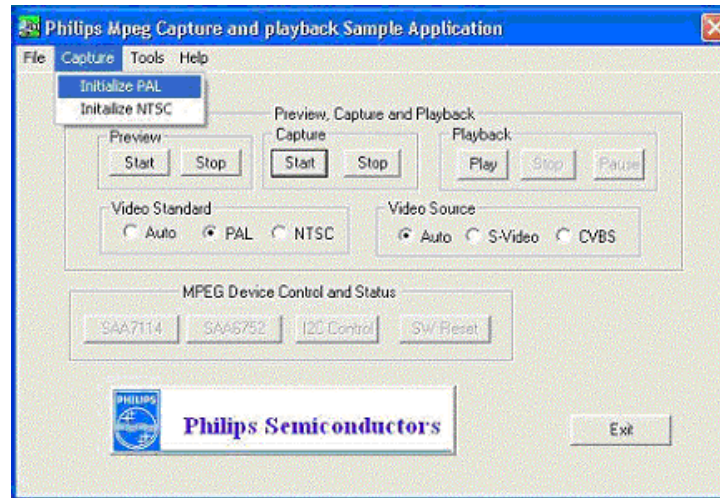

Figure 5-2: Selecting the Initialize PAL Command

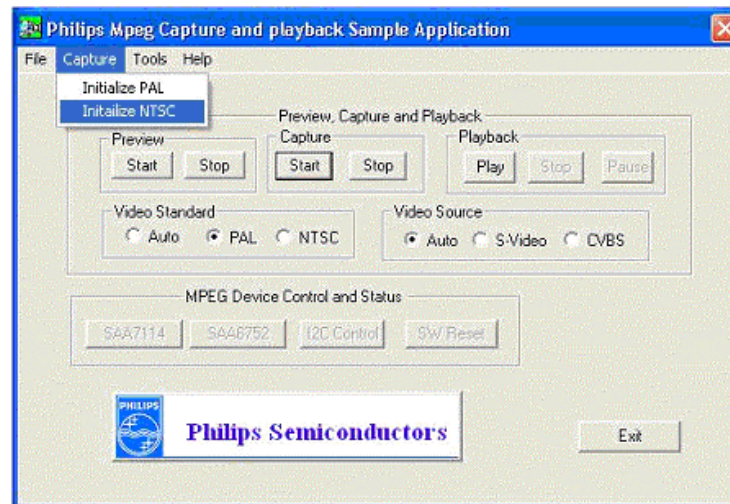

Figure 5-3: Selecting the Initialize NTSC Command

During initialization, the default initial script files will be sent to the board through the USB cable.

You can also select the TV standard (PAL or NTSC) and video input source (S-Video or CVBS) by clicking the appropriate option in the *Video Standard*¹ group and the *Video Source* group, respectively.



The application software can automatically detect the TV standard and video source, if the Auto option is enabled in the *Video Standard* group and *Video Source* group.

¹ In this document, names of windows, dialog boxes and groups are indicated in *italic*.

5.3.2. Running the Application

Using this application software, you can capture and preview the input A/V source. It also provides advanced hardware debugging functions.

Preview

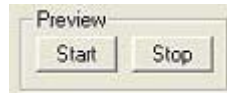

If you want to preview the input A/V source before storing it to the hard disk, use the Preview function.

1. To launch the preview operation and activate an *ActiveMovie Window*, click the **Start** button in the *Preview* group.

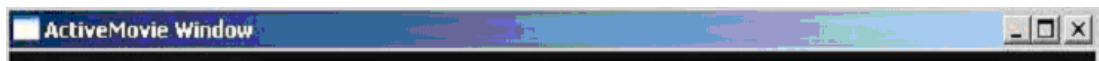

2. To terminate the preview operation, click the **Stop** button.

Capture



The Capture function can be used to capture the input A/V source and store this video signal in MPEG2 format on the hard disk of your PC.

1. To start the capture operation, click the **Start** button in the *Capture* group.
2. The *Open* dialog box appears; see Figure 5-4. Enter a file name for the movie or select an existing file, if you want to overwrite an existing file.

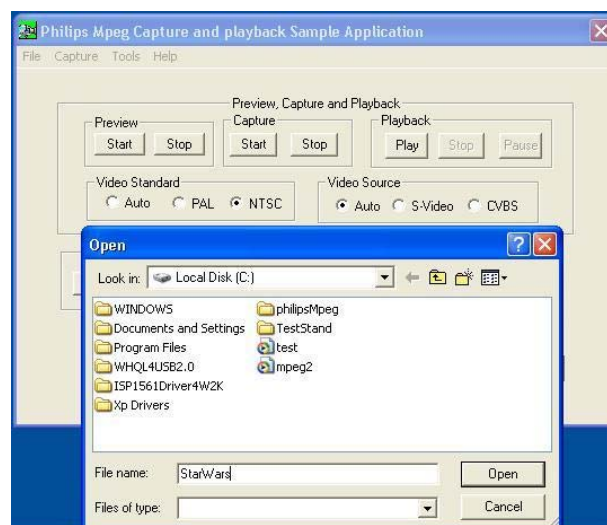

Figure 5-4: Open Dialog Box

3. Click **Open**. This will launch the capture operation.
4. To terminate the capture operation, click **Stop**.

Playback



Once an MPEG2 file is stored on the hard disk of your PC, you can use the functions under *Playback* to play the file.

6. Advanced Debugging Function

The application also provides a set of debugging functions for advanced user. It allows user using these functions to directly access the internal registers of SAA7114 and SAA6752.

6.1. Using Advanced Debugging Function

To enable the advanced debugging function, select **Debugging** from the *Tools* menu; see Figure 6-1. This activates the buttons under the *MPEG Device Control and Status* group.

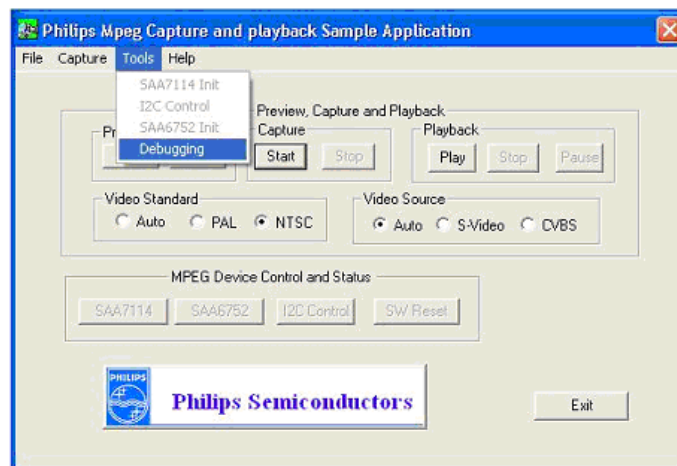

Figure 6-1: Selecting the Debugging Command

6.2. Using the SAA7114 Button

To directly access the internal registers of SAA7114, click **SAA7114** in the *MPEG Device Control and Status* group. This will open the *SAA7114 Initialization* dialog box for initializing SAA7114; see Figure 6-2.

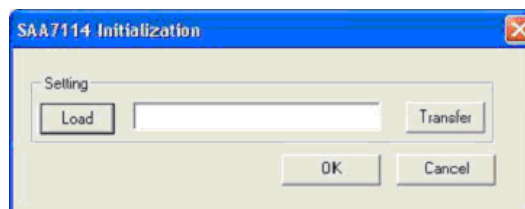

Figure 6-2: SAA7114 Initialization Dialog Box

In the *SAA7114 Initialization* dialog box, click the **Load** button and select file SAA7114PAL.URG (if you are using the PAL standard) or SAA7114NTSC_YC_020.URG (if you are using the NTSC standard), to initialize the SAA7114 chip. Then click the **Transfer** button to send the initial command to the chip. When the file transfer is complete, click **OK**.

6.3. Using the SAA6752 Button

To directly access the internal registers of SAA6752, choose **SAA6752** in the *MPEG Device Control and Status* group. This will open the *SAA6752 Initialization* dialog box for initializing SAA6752. The procedure to initialize SAA6752 is similar to the SAA7114 initialization procedure given in Section 6.2.

6.4. Using the I²C Control Button

The I²C control allows you to read data from and write data to the internal registers of SAA7114 and SAA6752. This operation is solely for advanced users having strong hardware background who wish to perform low-level debugging of the hardware. For more details on the I²C control operation, refer to the SAA6752 and SAA7114 datasheets—“*SAA6752HS MPEG-2 video and MPEG-audio/AC-3 audio encoder with multiplexer*” and “*SAA7114H PAL/NTSC/SECAM video decoder with adaptive PAL/NTSC comb filter, VBI-data slicer and high performance scaler*.” The general read and write operations are given in Figure 6-3 and Figure 6-4, respectively.

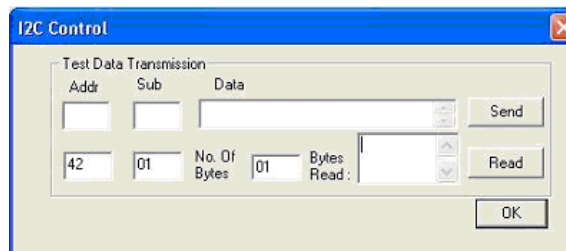

Figure 6-3: Read Operation

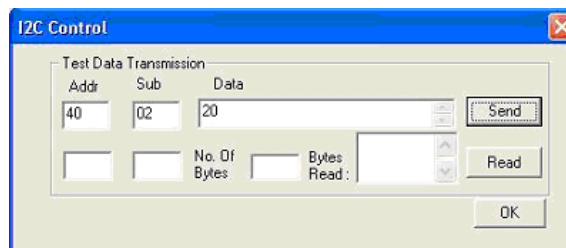

Figure 6-4: Write Operation

6.5. Using the SW Reset Button

Another advanced function is issuing a reset command through the USB cable to the SAA7114 and SAA6752 chips on the board by using the **SW Reset** button.

7. Hardware Description

This section briefly describes the hardware implementation of the MPEG2 encoder with Hi-Speed USB solution in terms of functions and connections between various interfaces. A functional block diagram of the reference design is given in Figure 7-1.

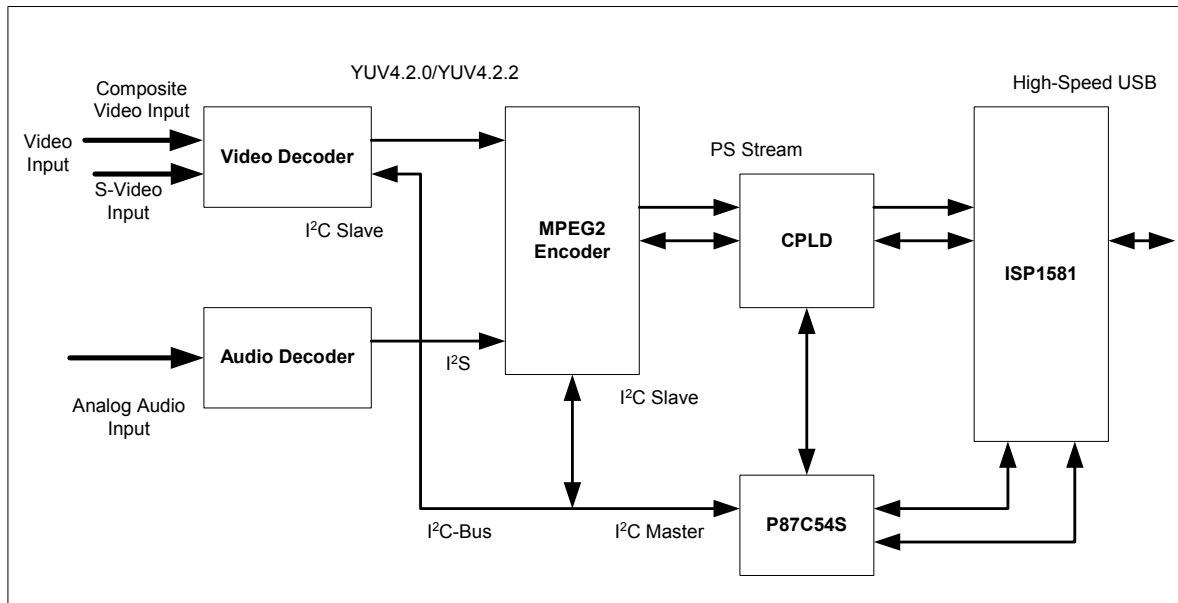

Figure 7-1: Functional Block Diagram of the USB MPEG2 Encoder Reference Kit

7.1. Video-Input Interface

The video-input interface consists of two analog inputs to connect Composite Video Bit Stream (CVBS) and Luminance Chrominance (YC) sources to the board. A video-input processor (VIP) SAA7114 is used on the board for video decoding and analog-to-digital conversion.

7.2. Analog Audio-Input Interface

The serial audio I²S ports are implemented on the board. These port can be provided with an analog input source, using the audio bit-stream analog-to-digital converter DA1361TS for generating the I²S signal.

7.3. MPEG Stream (PS Stream) Output Interface

The MPEG stream output port connects the SAA6752HS multiplexer to USB through a Complex Programmable Logic Device (CPLD). The MPEG stream is set to the Data Expansion Bus Interface (DEBI) slave mode. The output format is TTL. This interface also includes the data request signal as SAA6752HS input and the data validated signal as SAA6752HS output.

7.4. I²C-Bus Interface

The P87C52X2 MCU is a bus master. It relays all I²C-Bus commands from the host to different components on the board through the control pipe.

7.5. USB Device Endpoints

In the USB environment, pipes or endpoints are used for transferring data and commands. Each endpoint performs a task, such as, enumeration, configuration and vendor-specific device requests handling, and data streaming signaling the host. See Table 7-1 for endpoint types.

Table 7-1: Endpoint Types

| Endpoint | Transfer Mode | Direction |
|----------|---------------|-----------|
| 0 | Control | IN or OUT |
| 1 | Bulk | IN |

7.6. Power Supply

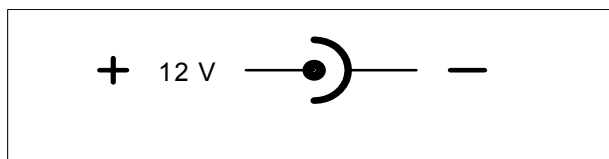

Figure 7-2: Polarity of the DC Power Supply Plug (Self-Powered Mode)

The demo board is designed to be self-powered. A DC power supply with 12 V, 1 amp is required.

8. Connector Pin information

Table 8-1: CON5 In-System Programming Port

| Pin | Name | Description |
|-----|------|---|
| 1 | 3V3D | 3.3 V DC power supply |
| 2 | TDO | Serial data output for all JTAG instructions and data registers |
| 3 | TCK | JTAG test clock |
| 4 | TMS | Mode input signal |
| 5 | TDI | Serial data Input for all JTAG instructions and data registers |
| 6 | DGND | Digital ground |

Table 8-2: CON3 DC Power Supply Input Port (DC Jack)

| Pin | Name | Description |
|-----|---------|----------------------------|
| 1 | 12V VCC | 12 V DC power supply input |
| 2 | DGND | Digital ground |
| 3 | DGND | Digital ground |

Table 8-3: CON6 USB Port

| Pin | Name | Description |
|-----|--------|---|
| 1 | VBUS | V_{BUS} is nominally +5 V at the source |
| 2 | USB D- | Negative differential signal of USB |
| 3 | USB D+ | Positive differential signal of USB |
| 4 | DGND | Digital ground |
| 5-6 | SHIELD | Shield ground |

Table 8-4: RCA1 USB Port

| Pin | Name | Description |
|-----|------|----------------------------|
| 1 | LEFT | Audio input (Left channel) |
| 2 | AGND | Analog ground |

Table 8-5: RCA2 USB Port

| Pin | Name | Description |
|-----|-------|-----------------------------|
| 1 | RIGHT | Audio input (Right channel) |
| 2 | AGND | Analog ground |

Table 8-6: RCA3 USB Port

| Pin | Name | Description |
|-----|------|----------------------------------|
| 1 | CVBS | Composite video bit-stream input |
| 2 | AGND | Analog ground |

Table 8-7: CON1 S-Video Port

| Pin | Name | Description |
|-----|------|---|
| 1 | GND | Analog ground |
| 2 | GND | Analog ground |
| 3 | C | Digital component video input (Chrominance) |
| 4 | Y | Digital component video input (Luminance) |

Table 8-8: CON7

| Pin | Name | Description |
|------|------|-------------|
| 1-20 | — | Reserved |

Table 8-9: CON2

| Pin | Name | Description |
|------|------|-------------|
| 1-33 | — | Reserved |

9. Jumper and Test Points

Table 9-1: JP1

| Pin | Name | Description |
|-----|------|-----------------------|
| 1 | 3V3D | 3.3 V DC power supply |
| 2 | 3V3D | 3.3 V DC power supply |

Table 9-2: JP2

| Pin | Name | Description |
|-----|------|----------------|
| 1 | DGND | Digital ground |
| 3 | DGND | Digital ground |

Table 9-3: JP3

| Pin | Name | Description |
|-----|------|---------------|
| 1 | AGND | Analog ground |
| 2 | AGND | Analog ground |

Table 9-4: JP4

| Pin | Name | Description |
|-----|------|-----------------------|
| 1 | V2V5 | 2.5 V DC power supply |
| 3 | V2V5 | 2.5 V DC power supply |

Table 9-5: JP5

| Pin | Name | Description |
|-----|------|---------------------|
| 1 | V5V | 5 V DC power supply |
| 3 | V5V | 5 V DC power supply |

Table 9-6: Solder Pad Jumper

| Name | Description |
|------------------------------|--------------------------|
| PD1 to PD12, PD29 | No connection (reserved) |
| PD30 to PD35, PD134 to PD135 | No connection (reserved) |
| PD51 | DGND, shorted |
| PD52 | AGND, shorted |

10. LED Indicators

Table 10-1: LED Indicators

| No | Name | Description |
|----|------|--|
| 1 | PWR | POWER ON indication |
| 2 | DACK | MPEG2 bit stream transferring indication |
| 3 | HS | USB Hi-Speed connection indication |

11. RESET Switches

Table 11-1: RESET Switches

| No | Name | Description |
|----|------|-------------|
| 1 | SW2 | MCU reset |

12. Schematics

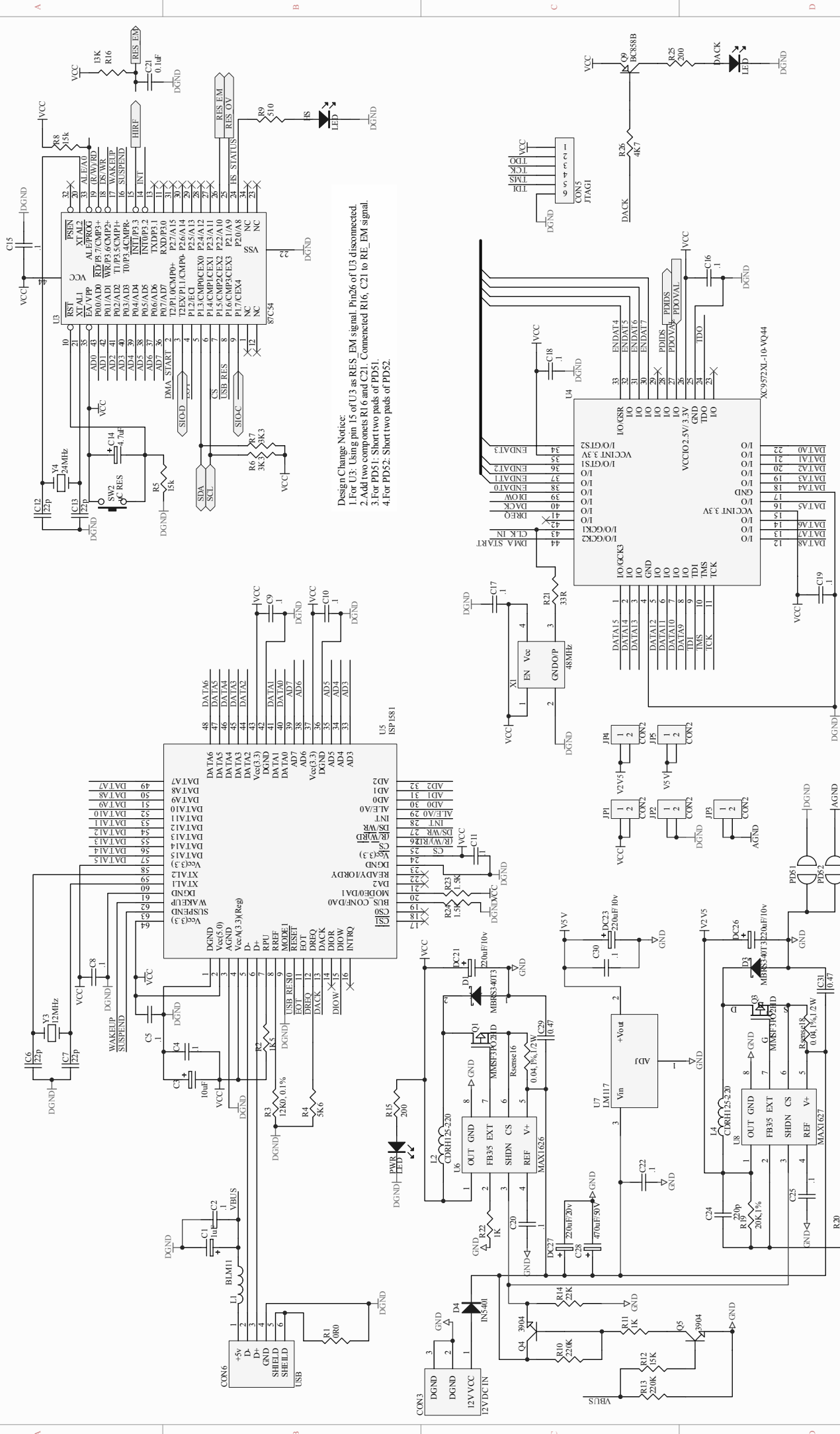

Design Change Notice:

1. For U3: Using pin 15 of U3 as RES_EM signal. Pin26 of U3 disconnected.
2. Add two components R16 and C21. Connected R16, C21 to RE_EM signal.
3. For PD51: Short two pads of PD51.
4. For PD52: Short two pads of PD52.

| Title | | Revision | |
|-------|---|----------|-----|
| Size | A3 | Number | |
| Date | 2003-12-02 | Sheet of | 8 |
| File | C:\Documents and Settings\... \DI-4\MCU-1 | Drawn by | sch |

USB MCU

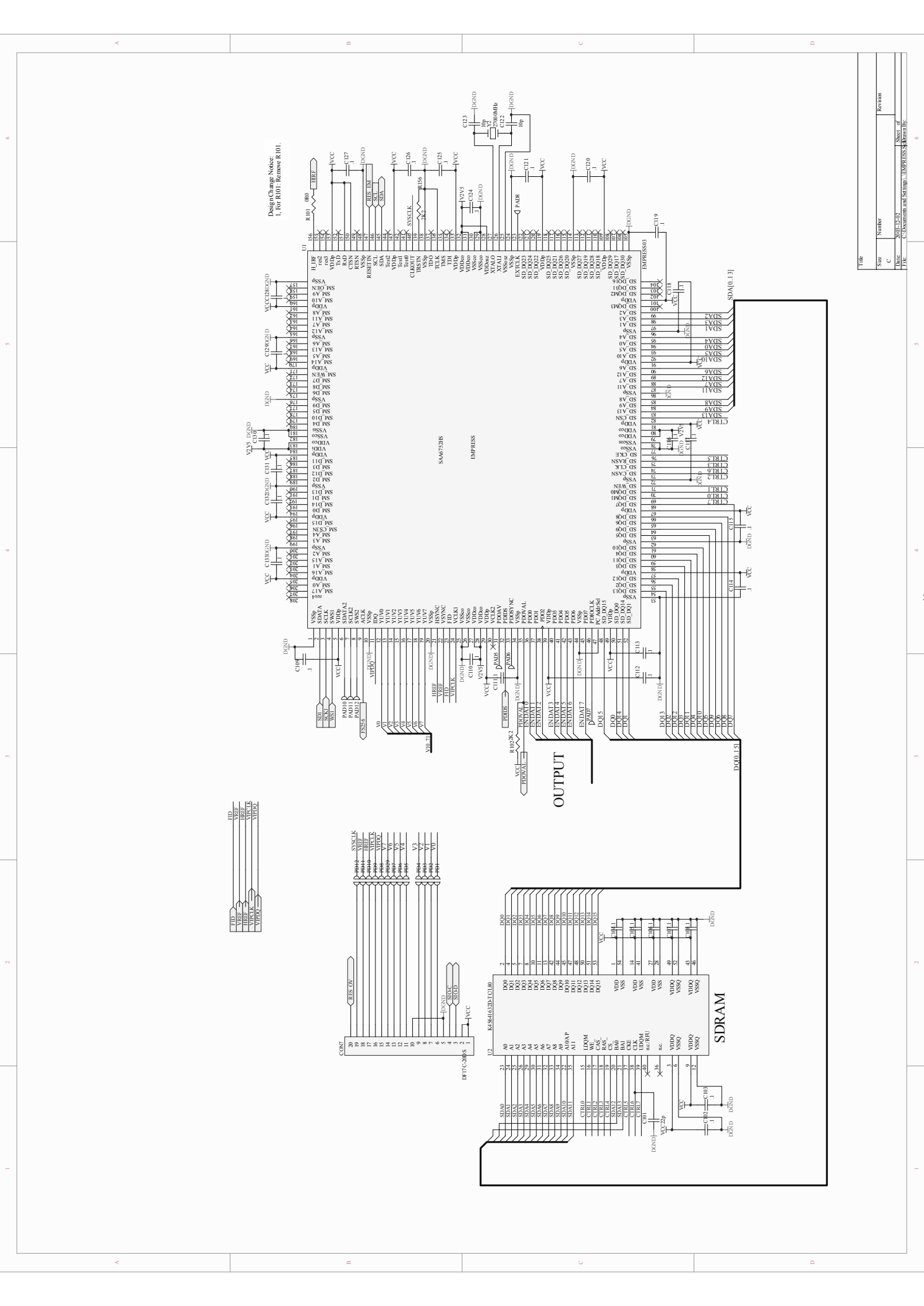

Design/Change Notice:
1. For R101: Remove R101.

OUTPUT

SDRAM

| File | Size | Number | Revision |
|---------|------------|--------|----------|
| EMPRESS | 2010-12-02 | | |
| EMPRESS | | | |
| EMPRESS | | | |

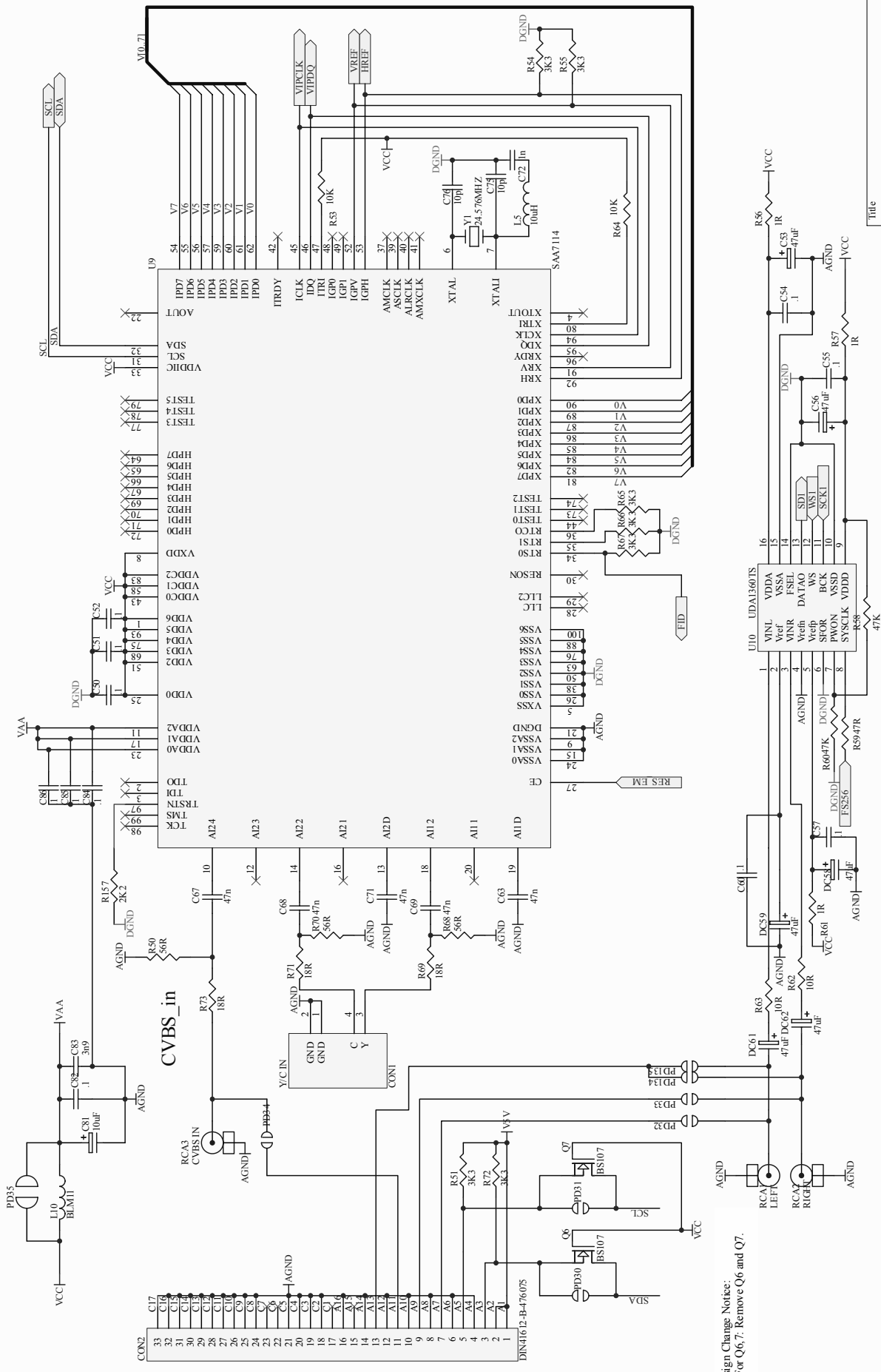

Design Change Notice:
1, For Q6,7: Remove Q6 and Q7.

| | | |
|-------|---------------------------------------|------------|
| Title | Number | Revision |
| | B | |
| Date: | 2003-12-02 | Sheet of 6 |
| File: | C:\Documents and Settings\Wickedn\sch | Drawn By: |

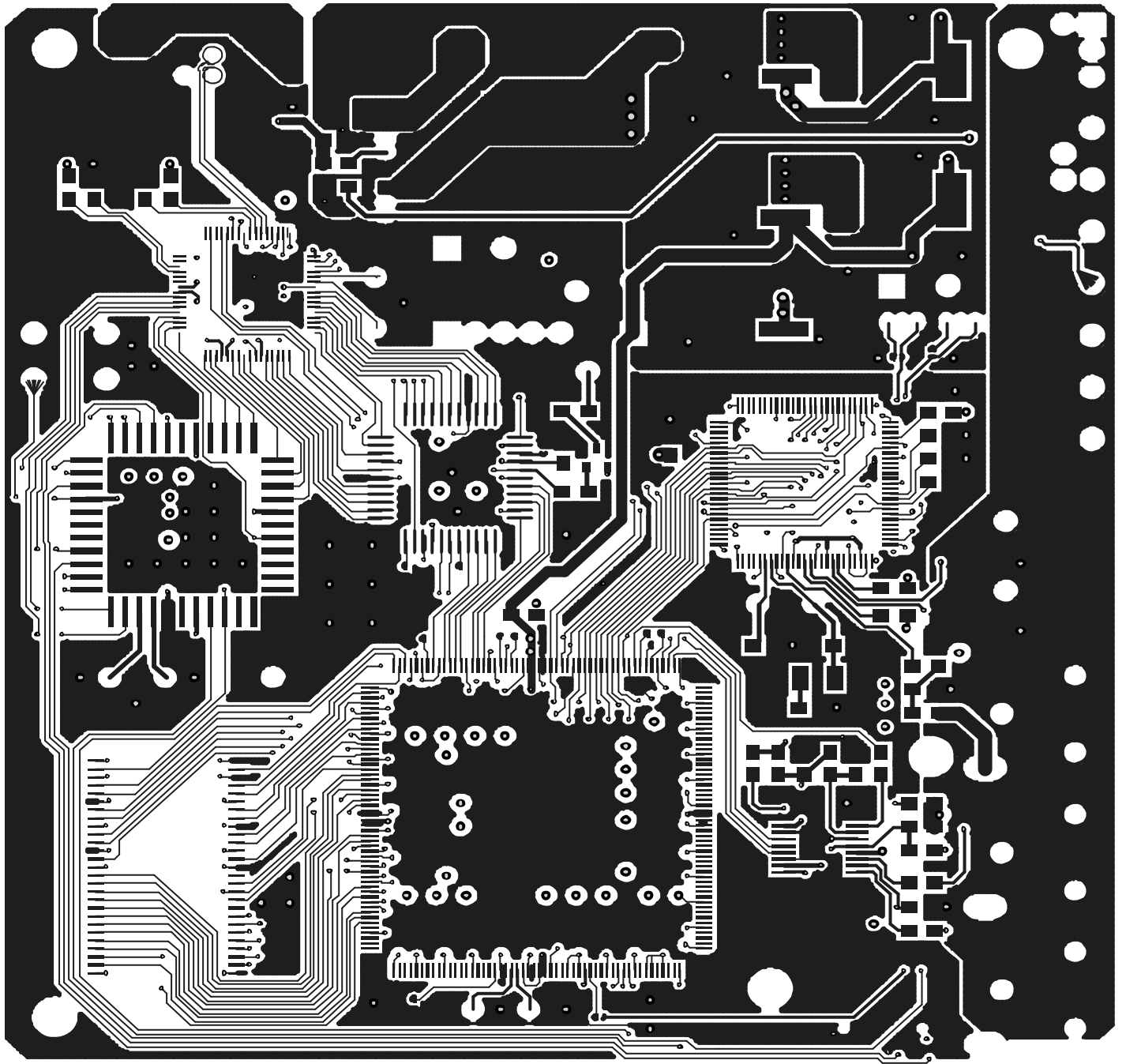

COMPONENT SIDE

1

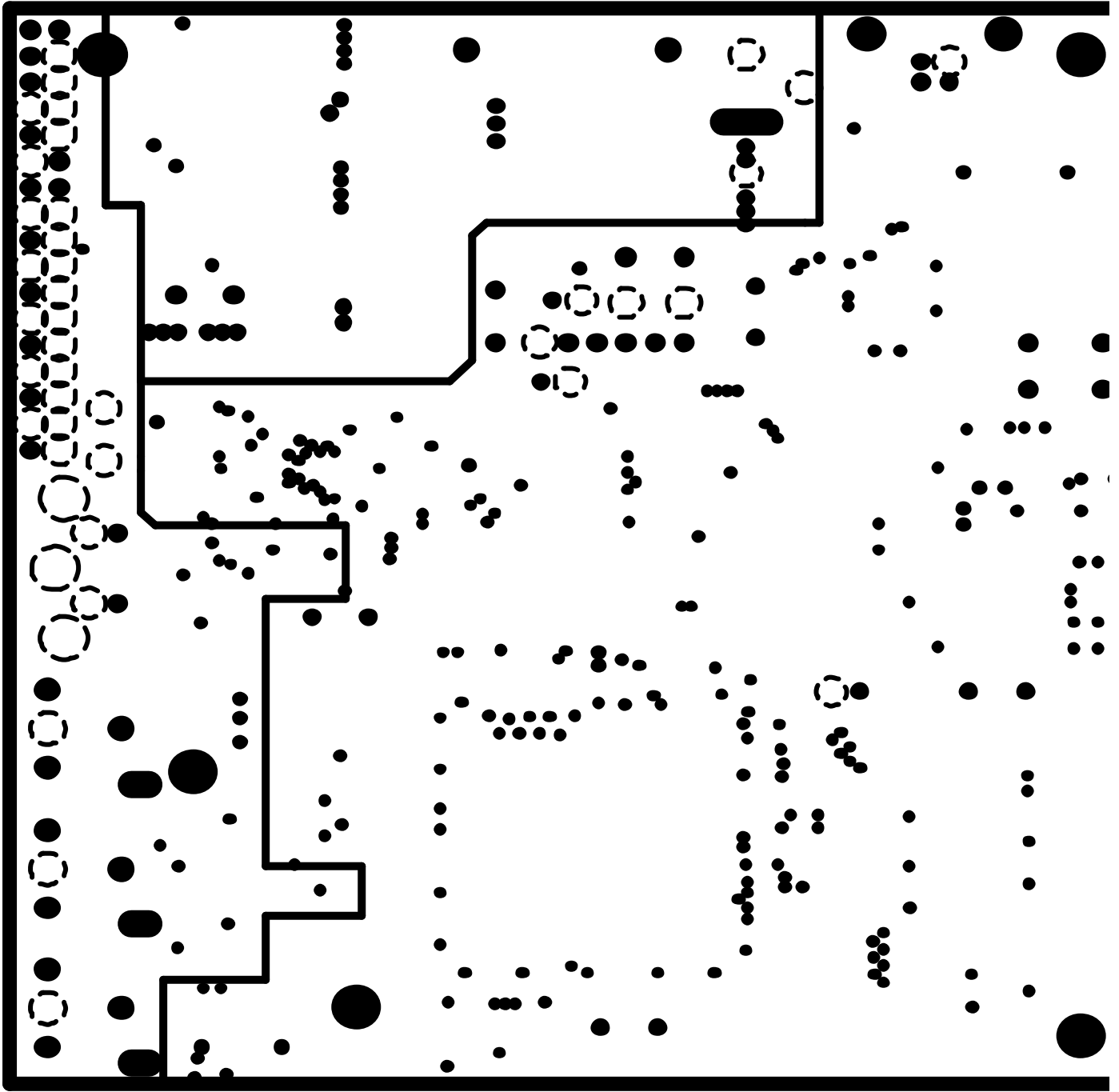

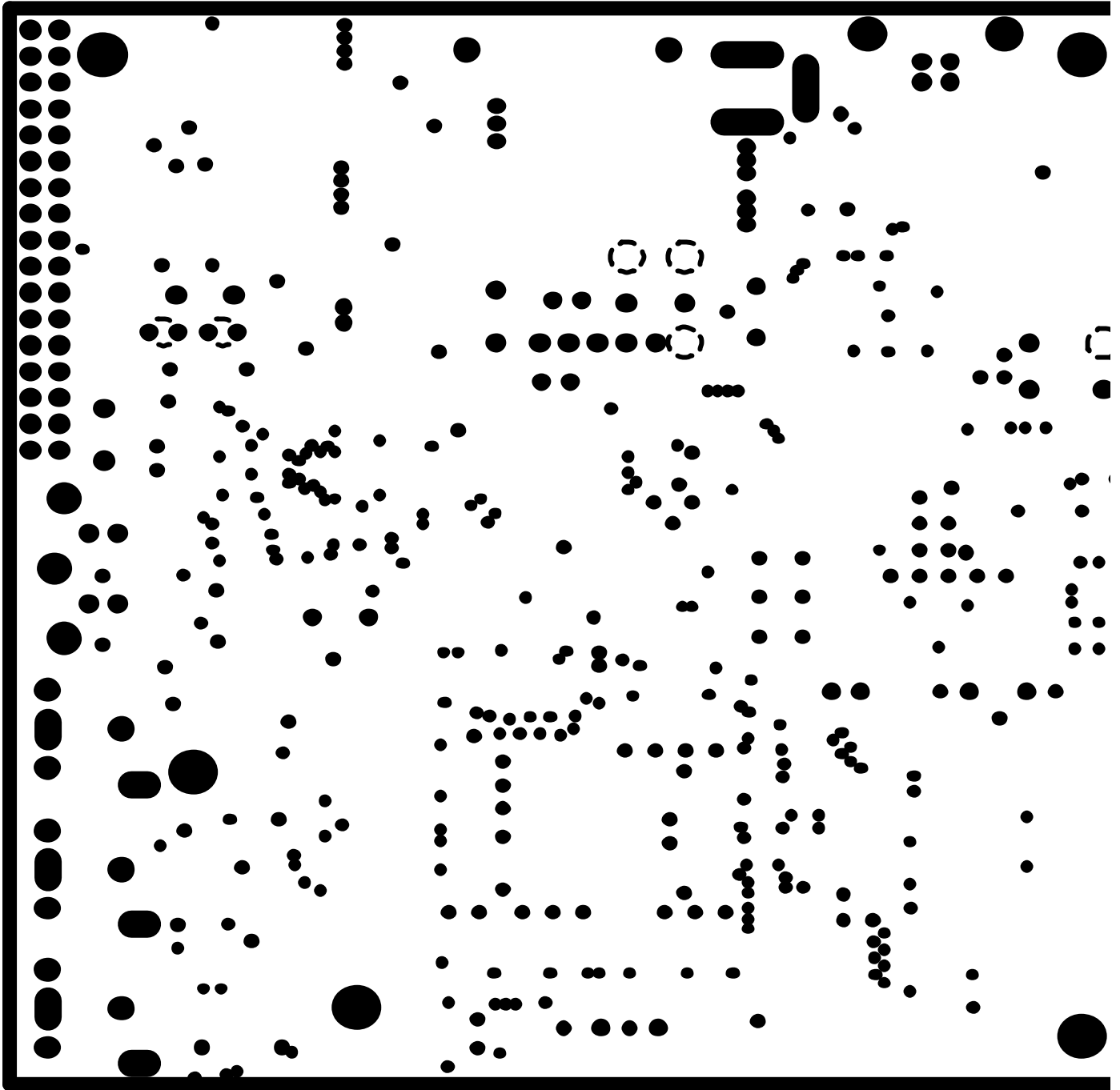

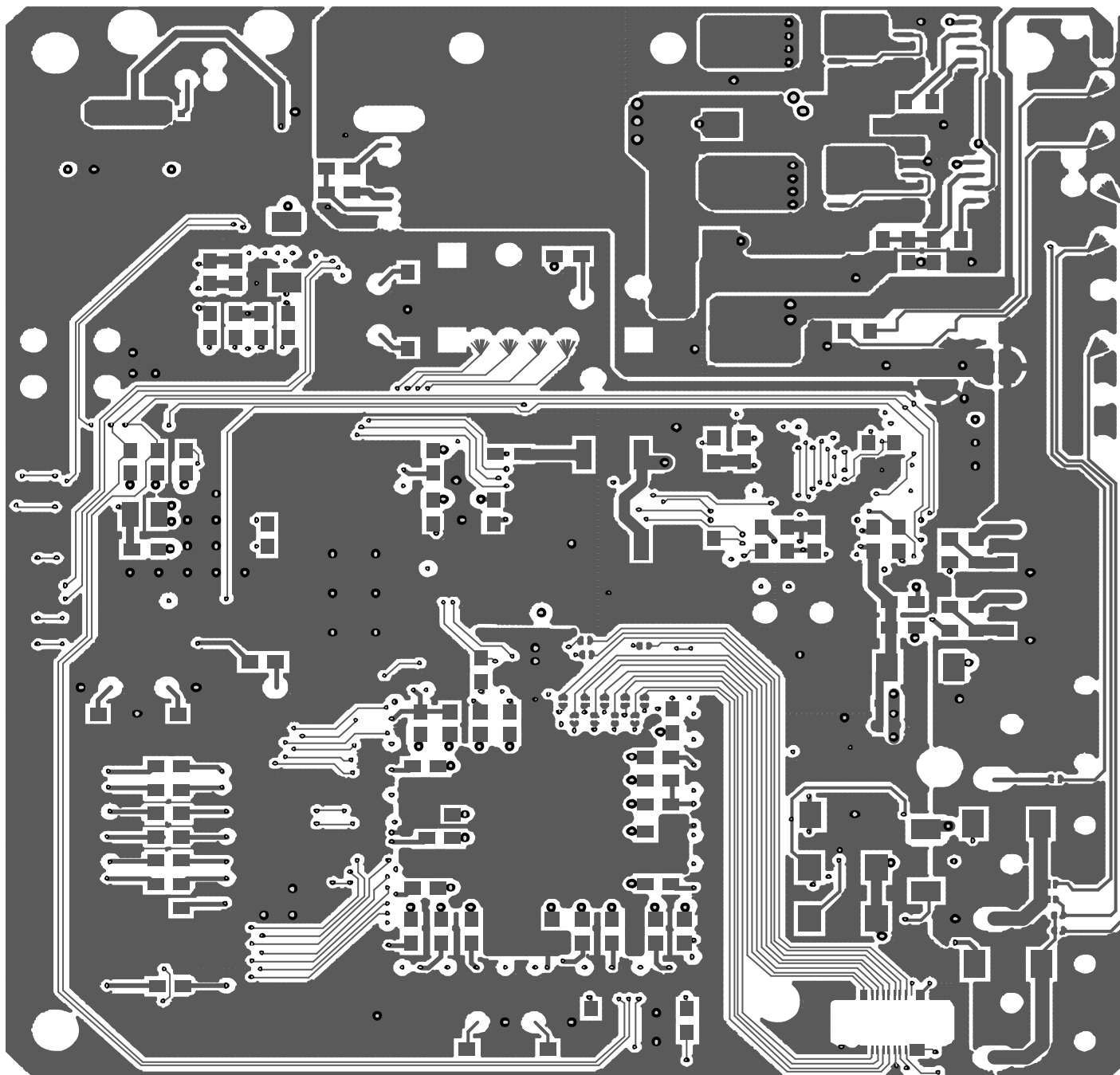

SOLDER SIDE

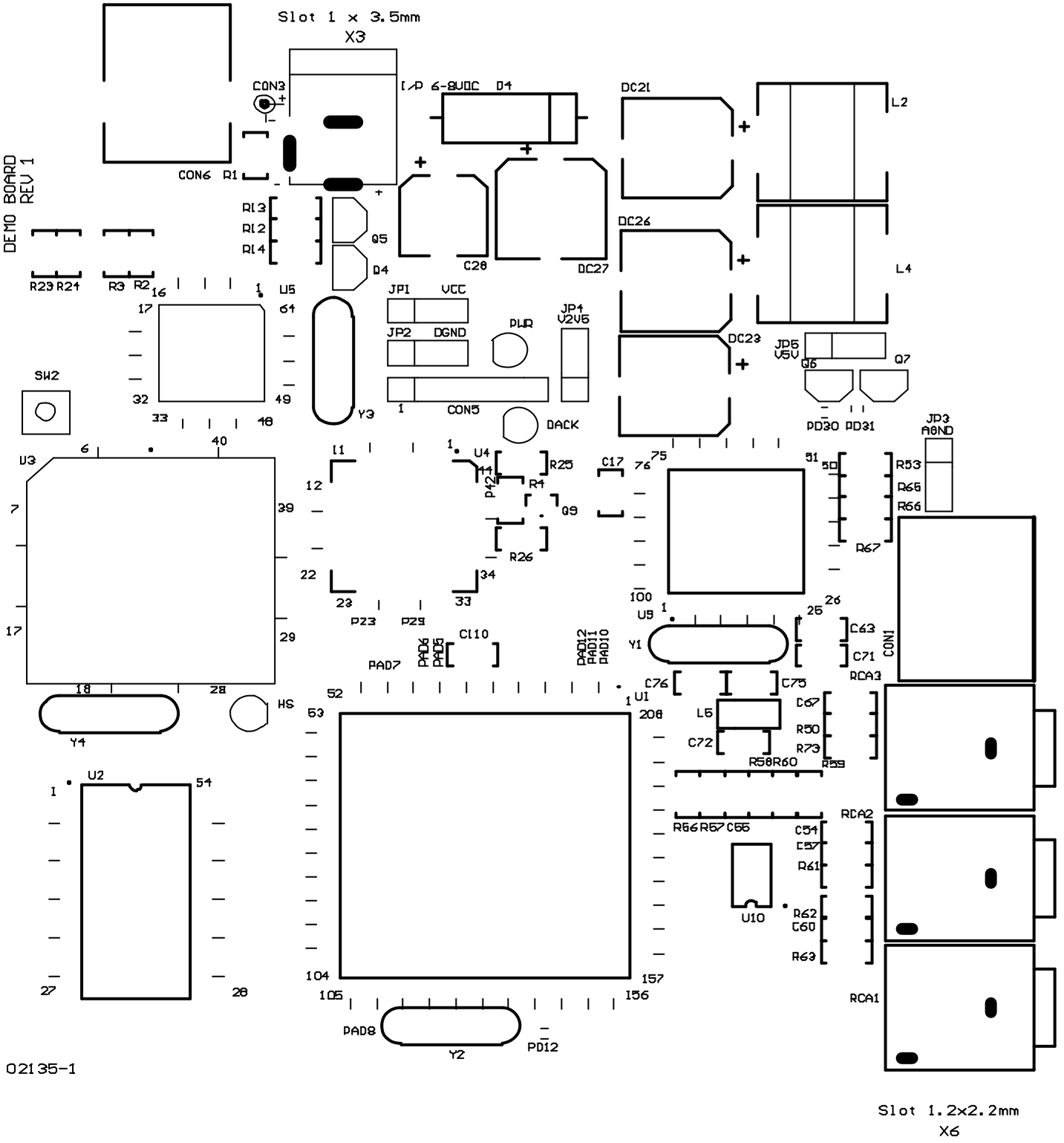

COMP SIDE LEGEND

13. Bill of Materials

| Quantity | Part Type | Designator | Footprint | Description |
|----------|------------------------|--|-----------|------------------------------------|
| 37 | — | PD1 PD11 PD13 PD15 PD17 PD19 PD2 PD21 PD23 PD25 PD27 PD28 PD29 PD3 PD30 PD31 PD32 PD33 PD34 PD35 PD36 PD37 PD38 PD39 PD4 PD40 PD41 PD42 PD43 PD44 PD45 PD46 PD47 PD5 PD6 PD8 PD9 | SIP2-S | — |
| 3 | 0.01 μ F | C18 C19 C20 | 0805 | Capacitor nonpolar |
| 1 | 0.027 μ F, 1 kV | C26 | 1206 | Capacitor nonpolar |
| 16 | 0.1 μ F | C1 C10 C11 C12 C13 C14 C15 C2 C3 C32 C4 C5 C6 C7 C8 C9 | 0805 | Capacitor nonpolar |
| 3 | 0 R | R17 R18 R31 | | Resistor |
| 1 | 10 k | R19 | 0805 | Resistor |
| 3 | 120 k | R3 R4 R5 | 0805 | Resistor |
| 1 | 12K0, 0.1% | R9 | 0805 | Resistor |
| 1 | 12 MHz | Y1 | CRYSTAL | — |
| 2 | 15 k | R11 R12 | 0805 | Resistor |
| 1 | 180 R | R7 | 0805 | Resistor |
| 2 | 1 k | R1 R2 | 0805 | — |
| 1 | 1K5 | R8 | 0805 | — |
| 1 | 1 μ F | C27 | CASE A | Capacitor nonpolar |
| 4 | 20 pF | C22 C23 C24 C25 | 0805 | Capacitor nonpolar |
| 1 | 220 n | C31 | 0805 | Capacitor nonpolar |
| 1 | 24 MHz | Y2 | CRYSTAL | — |
| 1 | 2N3904 | Q4 | | — |
| 11 | 33 R | R20 R21 R22 R23 R24 R25 R26 R27 R28 R29 R30 | 0805 | — |
| 4 | 3K3 | R13 R14 R15 R16 | 0805 | — |
| 1 | 3n9 | C29 | 0805 | Capacitor nonpolar |
| 1 | 3V3D | JP1 | SIP2-J | — |
| 2 | 4.7 μ F | C21 C30 | RB.2/.2 | Capacitor nonpolar |
| 2 | 47 μ F | C16 C17 | RB.2/.2 | Capacitor nonpolar |
| 1 | 48 MHz | X1 | DIP14/OSC | — |
| 1 | 4K7 | R6 | 0805 | Resistor |
| 1 | 5K6 | R10 | 0805 | — |
| 1 | 74LVC08 | U4 | SO14 | Quad 2-In POS and G |
| 1 | 7805 (8 V to 5.0 V) | U3 | TO252 | — |
| 1 | 820 n | C28 | 0805 | Capacitor nonpolar |
| 1 | 87C54 | U6 | DIP40 | — |
| 1 | BC858B | Q1 | PNP | PNP Bipolar transistor |
| 6 | BLM11 | L1 L2 L3 L4 L5 L7 | 0805A | Inductor |
| 2 | BS107 | Q2 Q3 | MOSFET | — |
| 1 | CD +8 V | CON3 | | RCA connector |
| 1 | DEBI | CON2 | | — |
| 1 | DGND | JP2 | SIP2-J | — |
| 1 | ENCODING | LED2 | LED-SMT | — |
| 1 | HS | LED3 | | — |
| 1 | I2C | CON5 | SIP4 | — |
| 1 | ISP1581 | U5 | IC51A | Hi-Speed USB Peripheral Controller |

| Quantity | Part Type | Designator | Footprint | Description |
|----------|--------------------------|------------|-----------|-------------|
| 1 | JTAGI | CON1 | SIP6 | Connector |
| 1 | LM1117 (8 V to 3.3 V) | U2 | TO252 | — |
| 1 | PWR ON | LED1 | | — |
| 1 | μC RES | SW1 | SW-TACT | — |
| 1 | USB | CON4 | | — |
| 1 | USB RES | SW2 | SW-TACT | — |
| 1 | XC9572XL-10- VQ44 | U1 | VQ44 | — |

14. Known Issues

- Does not support Windows 98.
- Does not support the USB full-speed mode.
- When playing a captured MPEG2 file from the hard disk, you may encounter video picture jogging because the freeware version (Copyright Moonlight Cordless LIMITED) of the decoder software is used with this version of the reference kit.
 - Read the license.txt file of the decoder software before use.
 - For better quality pictures, get commercial version of the decoder software.
- MFC application error occasionally encountered, if MSVCRTD.DLL is not present on the system. Copy MSVCRTD.DLL from the Application directory to the \System32 directory of your PC.

15. References

- *Universal Serial Bus Specification Rev. 2.0* (www.usb.org)
- *ISP1581 Hi-Speed Universal Serial Bus interface device data sheet* (<http://www.semiconductors.philips.com/pip/isp1581/>)